

General Description

The GreenMOS® high voltage MOSFET utilizes charge balance technology to achieve outstanding low on-resistance and lower gate charge. It is engineered to minimize conduction loss, provide superior switching performance and robust avalanche capability.

The GreenMOS® Generic series is optimized for extreme switching performance to minimize switching loss. It is tailored for high power density applications to meet the highest efficiency standards.

Features

- Low $R_{DS(ON)}$ & FOM
- Extremely low switching loss
- Excellent stability and uniformity

GreenMOS®



Applications

- PC power
- LED lighting
- Telecom power
- Server power
- EV Charger
- Solar/UPS

Key Performance Parameters

Parameter	Value	Unit
$V_{DS, min} @ T_{j(max)}$	750	V
$I_D, pulse$	30	A
$R_{DS(ON)}, max @ V_{GS}=10V$	500	mΩ
Q_g	12.3	nC

Marking Information

Product Name	Package	Marking
OSG70R500FF	TO220F	OSG70R500F

Package & Pin Information

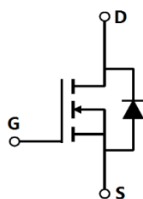

Absolute Maximum Ratings at $T_j=25^{\circ}\text{C}$ unless otherwise noted

Parameter	Symbol	Value	Unit
Drain-source voltage	V_{DS}	700	V
Gate-source voltage	V_{GS}	± 30	V
Continuous drain current ¹⁾ , $T_C=25^{\circ}\text{C}$	I_D	10	A
Continuous drain current ¹⁾ , $T_C=100^{\circ}\text{C}$		6.3	
Pulsed drain current ²⁾ , $T_C=25^{\circ}\text{C}$	$I_{D, pulse}$	30	A
Continuous diode forward current ¹⁾ , $T_C=25^{\circ}\text{C}$	I_S	10	A
Diode pulsed current ²⁾ , $T_C=25^{\circ}\text{C}$	$I_{S, pulse}$	30	A
Power dissipation ³⁾ , $T_C=25^{\circ}\text{C}$	P_D	31	W
Single pulsed avalanche energy ⁵⁾	E_{AS}	272	mJ
MOSFET dv/dt ruggedness, $V_{DS}=0\dots 480\text{ V}$	dv/dt	50	V/ns
Reverse diode dv/dt, $V_{DS}=0\dots 480\text{ V}$, $I_{SD}\leq I_D$	dv/dt	15	V/ns
Operation and storage temperature	T_{stg}, T_j	-55 to 150	$^{\circ}\text{C}$

Thermal Characteristics

Parameter	Symbol	Value	Unit
Thermal resistance, junction-case	$R_{\theta JC}$	4	$^{\circ}\text{C/W}$
Thermal resistance, junction-ambient ⁴⁾	$R_{\theta JA}$	62.5	$^{\circ}\text{C/W}$

Electrical Characteristics at $T_j=25^{\circ}\text{C}$ unless otherwise specified

Parameter	Symbol	Min.	Typ.	Max.	Unit	Test condition
Drain-source breakdown voltage	BV_{DSS}	700			V	$V_{GS}=0\text{ V}$, $I_D=250\ \mu\text{A}$
		750	810			$V_{GS}=0\text{ V}$, $I_D=250\ \mu\text{A}$, $T_j=150^{\circ}\text{C}$
Gate threshold voltage	$V_{GS(th)}$	2.0		4.0	V	$V_{DS}=V_{GS}$, $I_D=250\ \mu\text{A}$
Drain-source on-state resistance	$R_{DS(ON)}$		0.40	0.50	Ω	$V_{GS}=10\text{ V}$, $I_D=5\text{ A}$
			1.1			$V_{GS}=10\text{ V}$, $I_D=5\text{ A}$, $T_j=150^{\circ}\text{C}$
Gate-source leakage current	I_{GSS}			100	nA	$V_{GS}=30\text{ V}$
				-100		$V_{GS}=-30\text{ V}$
Drain-source leakage current	I_{DSS}			1	μA	$V_{DS}=700\text{ V}$, $V_{GS}=0\text{ V}$

Dynamic Characteristics

Parameter	Symbol	Min.	Typ.	Max.	Unit	Test condition
Input capacitance	C_{iss}		715.2		pF	$V_{GS}=0\text{ V}$, $V_{DS}=50\text{ V}$, $f=1\text{ MHz}$
Output capacitance	C_{oss}		50.5		pF	
Reverse transfer capacitance	C_{rss}		2.27		pF	
Turn-on delay time	$t_{d(on)}$		24.7		ns	$V_{GS}=10\text{ V}$, $V_{DS}=400\text{ V}$, $R_G=25\ \Omega$, $I_D=5\text{ A}$
Rise time	t_r		12.8		ns	
Turn-off delay time	$t_{d(off)}$		43		ns	
Fall time	t_f		23.1		ns	

Gate Charge Characteristics

Parameter	Symbol	Min.	Typ.	Max.	Unit	Test condition
Total gate charge	Q_g		12.3		nC	$V_{GS}=10\text{ V}$, $V_{DS}=400\text{ V}$, $I_D=5\text{ A}$
Gate-source charge	Q_{gs}		3.6		nC	
Gate-drain charge	Q_{gd}		4.4		nC	
Gate plateau voltage	$V_{plateau}$		5.6		V	

Body Diode Characteristics

Parameter	Symbol	Min.	Typ.	Max.	Unit	Test condition
Diode forward voltage	V_{SD}			1.3	V	$I_S=10\text{ A}$, $V_{GS}=0\text{ V}$
Reverse recovery time	t_{rr}		213		ns	$V_R=400\text{ V}$, $I_S=5\text{ A}$, $di/dt=100\text{ A}/\mu\text{s}$
Reverse recovery charge	Q_{rr}		2		μC	
Peak reverse recovery current	I_{rrm}		15.8		A	

Note

- 1) Calculated continuous current based on maximum allowable junction temperature.
- 2) Repetitive rating; pulse width limited by max. junction temperature.
- 3) P_d is based on max. junction temperature, using junction-case thermal resistance.
- 4) The value of $R_{\theta JA}$ is measured with the device mounted on 1 in 2 FR-4 board with 2oz. Copper, in a still air environment with $T_a=25\text{ }^\circ\text{C}$.
- 5) $V_{DD}=100\text{ V}$, $V_{GS}=10\text{ V}$, $L=10.8\text{ mH}$, starting $T_j=25\text{ }^\circ\text{C}$.

Electrical Characteristics Diagrams

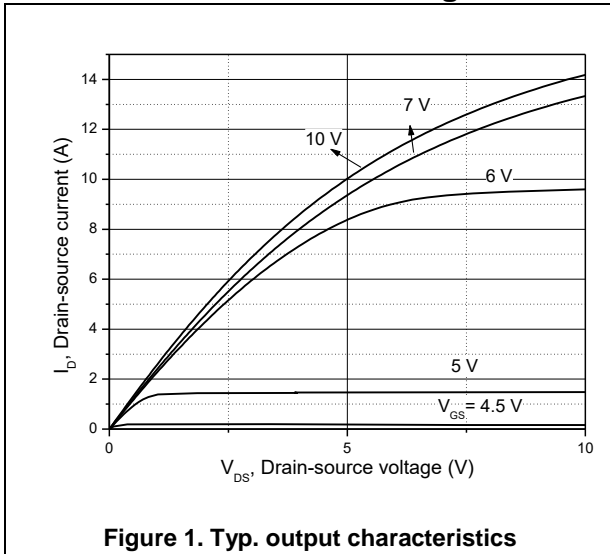

Figure 1. Typ. output characteristics

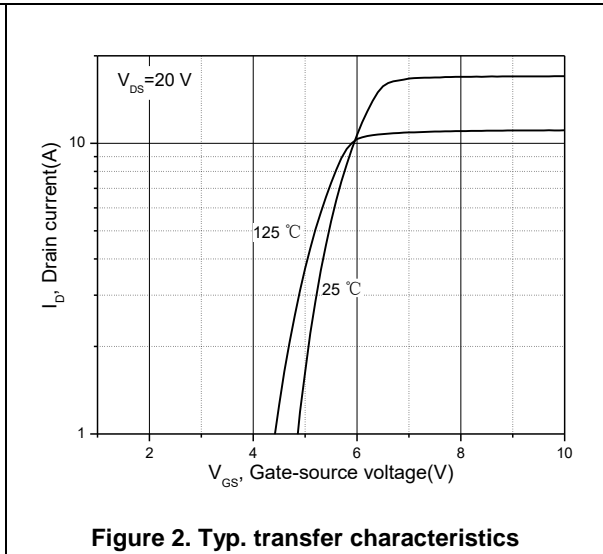

Figure 2. Typ. transfer characteristics

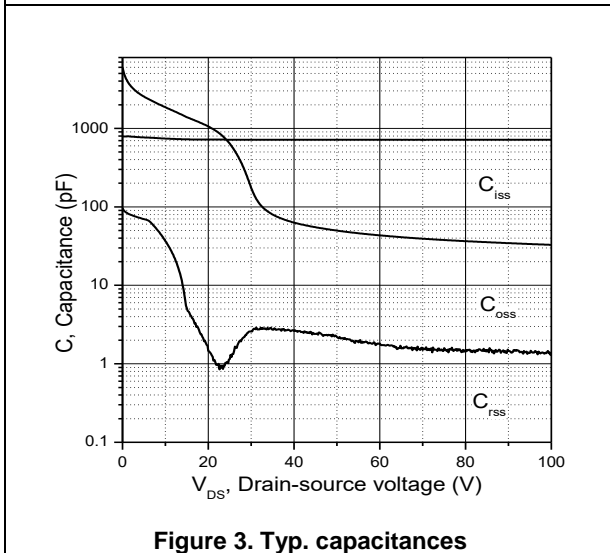

Figure 3. Typ. capacitances

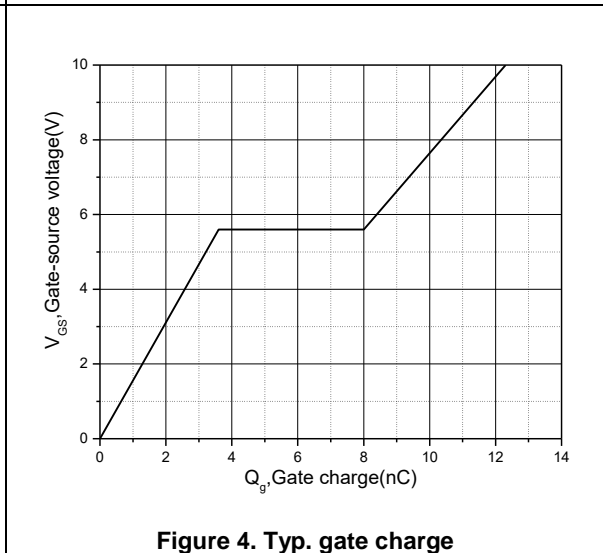

Figure 4. Typ. gate charge

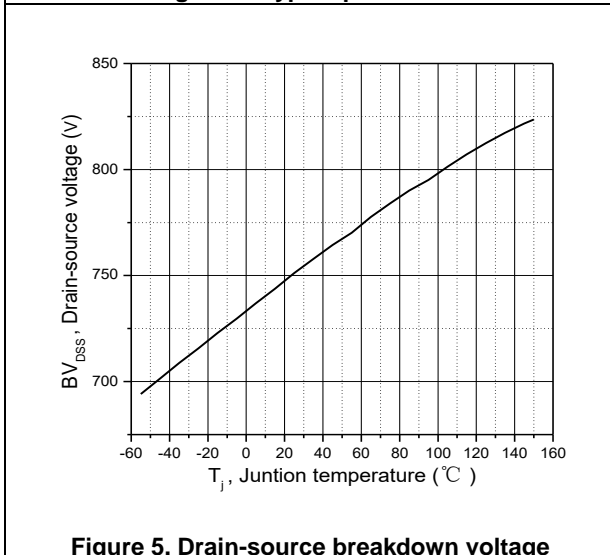

Figure 5. Drain-source breakdown voltage

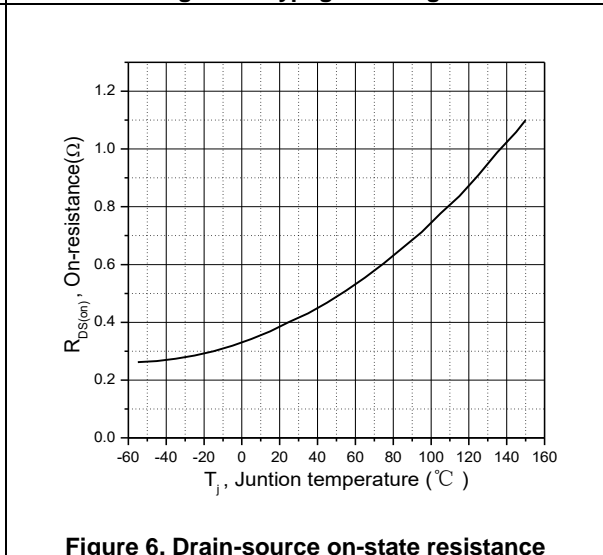

Figure 6. Drain-source on-state resistance

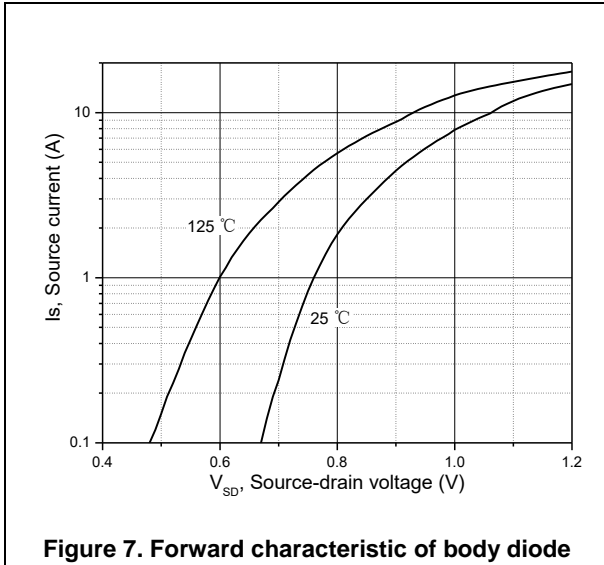

Figure 7. Forward characteristic of body diode

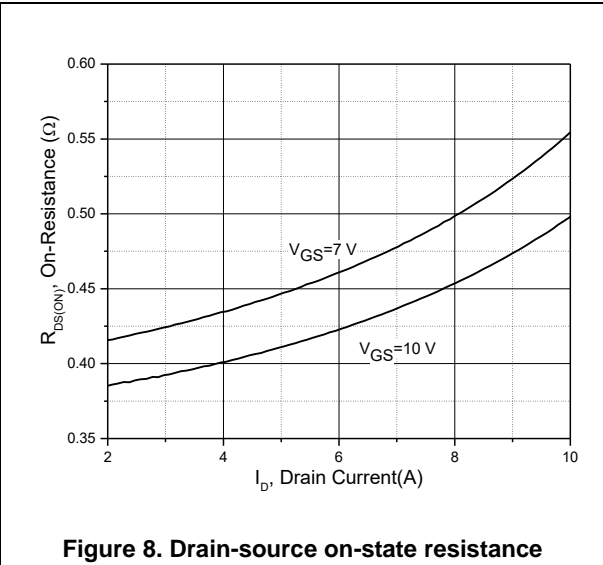

Figure 8. Drain-source on-state resistance

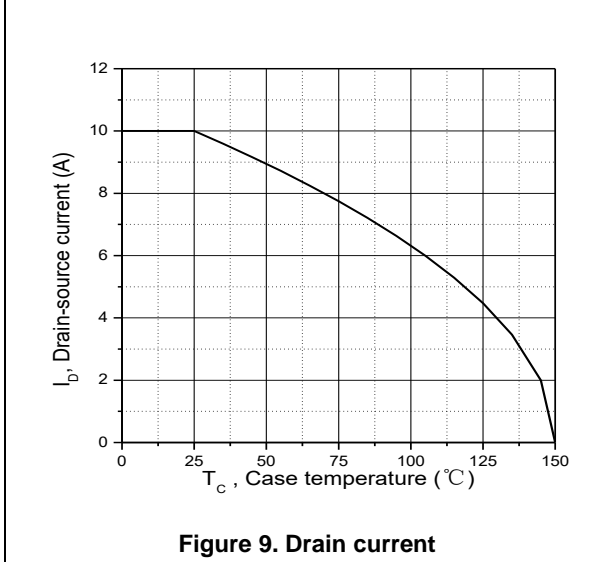

Figure 9. Drain current

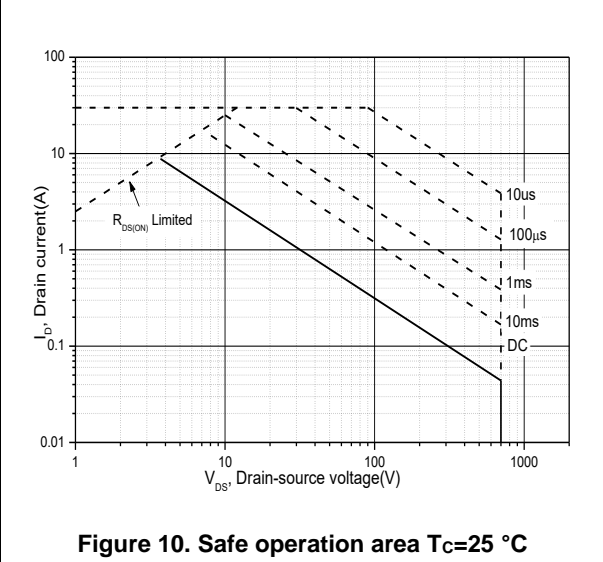

Figure 10. Safe operation area TC=25 °C

Test circuits and waveforms



Figure 1. Gate charge test circuit & waveform



Figure 2. Switching time test circuit & waveforms

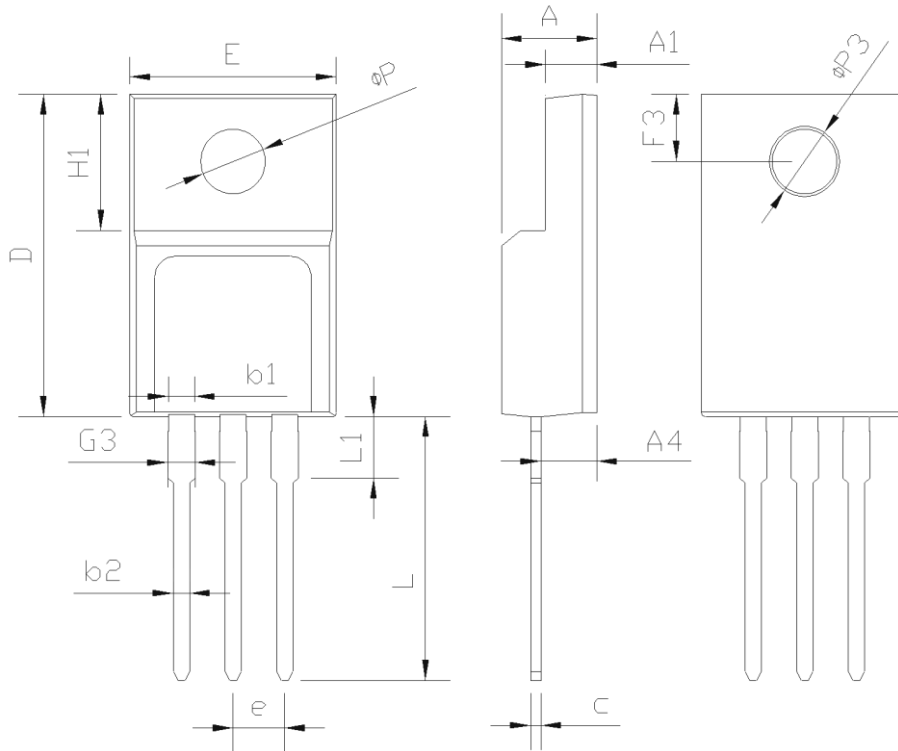

Figure 3. Unclamped inductive switching (UIS) test circuit & waveforms



Figure 4. Diode reverse recovery test circuit & waveforms

Package Information



Symbol	mm		
	Min	Nom	Max
E	9.96	10.16	10.36
A	4.50	4.70	4.90
A1	2.34	2.54	2.74
A4	2.56	2.76	2.96
c	0.40	0.50	0.65
D	15.57	15.87	16.17
H1	6.70REF		
e	2.54BSC		
L	12.68	12.98	13.28
L1	2.88	3.03	3.18
ΦP	3.03	3.18	3.38
ΦP3	3.15	3.45	3.65
F3	3.15	3.30	3.45
G3	1.25	1.35	1.55
b1	1.18	1.28	1.43
b2	0.70	0.80	0.95

Version 1: TO220F-C package outline dimension

Ordering Information

Package Type	Units/ Tube	Tubes/ Inner Box	Units/ Inner Box	Inner Boxes/ Carton Box	Units/ Carton Box
TO220F-C	50	20	1000	6	6000

Product Information

Product	Package	Pb Free	RoHS	Halogen Free
OSG70R500FF	TO220F	yes	yes	yes

Legal Disclaimer

The information given in this document shall in no event be regarded as a guarantee of conditions or characteristics. With respect to any examples or hints given herein, any typical values stated herein and/or any information regarding the application of the device, Oriental Semiconductor hereby disclaims any and all warranties and liabilities of any kind, including without limitation, warranties of non-infringement of intellectual property rights of any third party.

For further information on technology, delivery terms and conditions and prices, please contact the Oriental Semiconductor sales representatives (www.orientalsemi.com).

© Oriental Semiconductor Co.,Ltd. All Rights Reserved 